

het boek

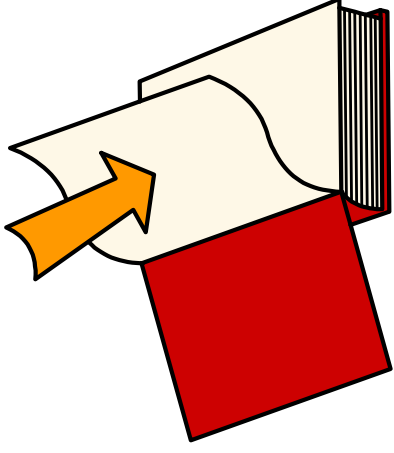

de bladzijde



de stapel



het verhaal

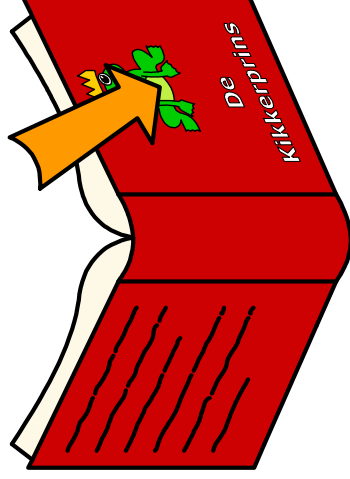

de voorkant

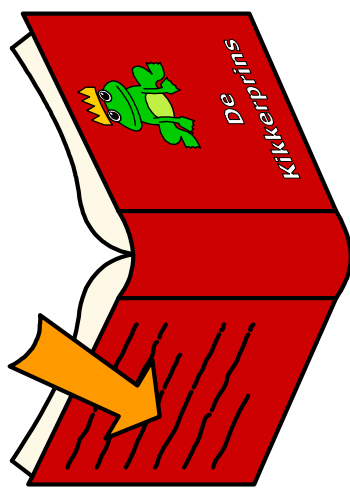

de achterkant

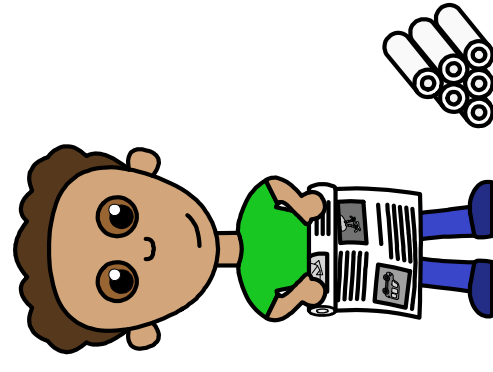

oprollen

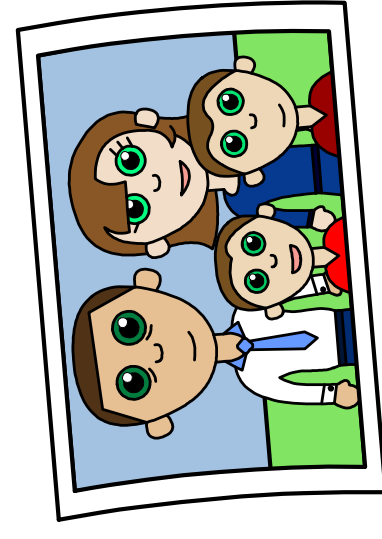

de foto

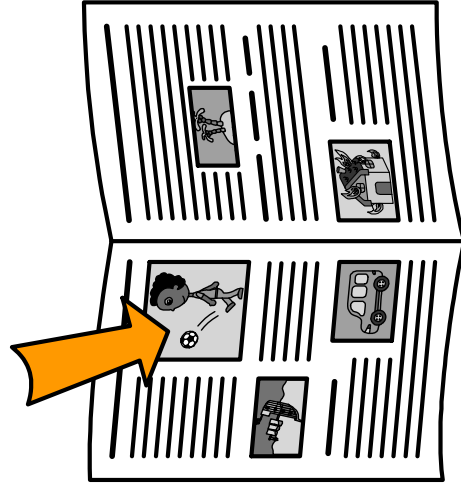

het plaatje

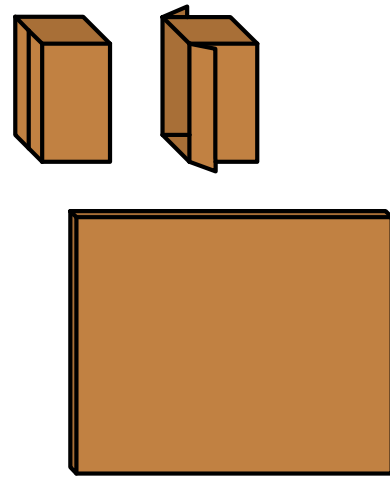

het karton

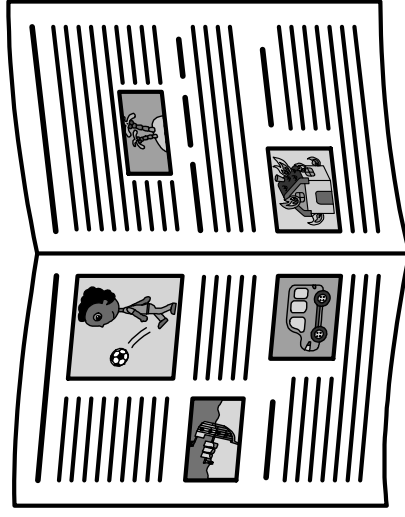

de krant

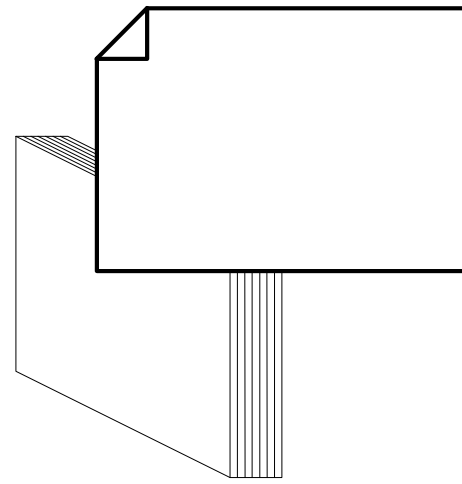

het papier



terugbrengen

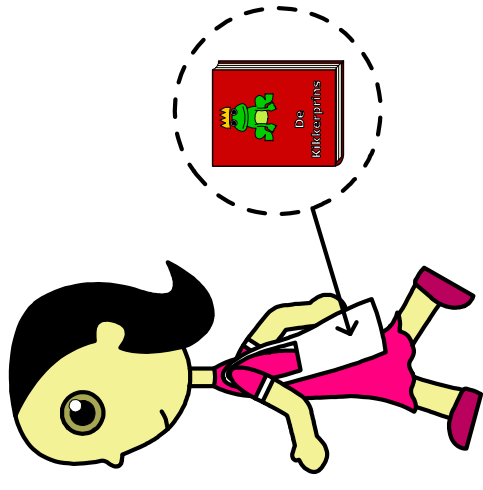

meenemen

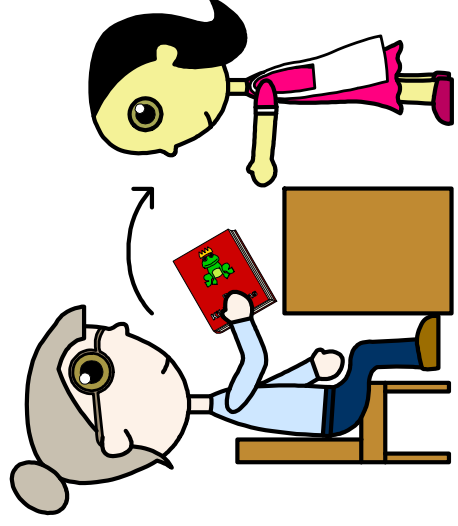

lenen

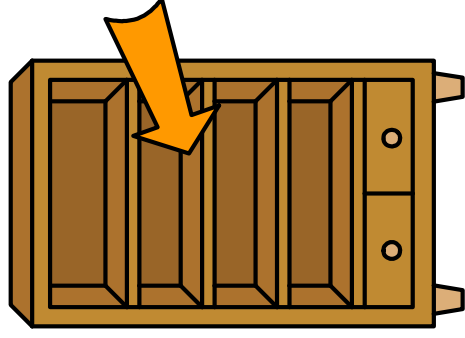

de plank

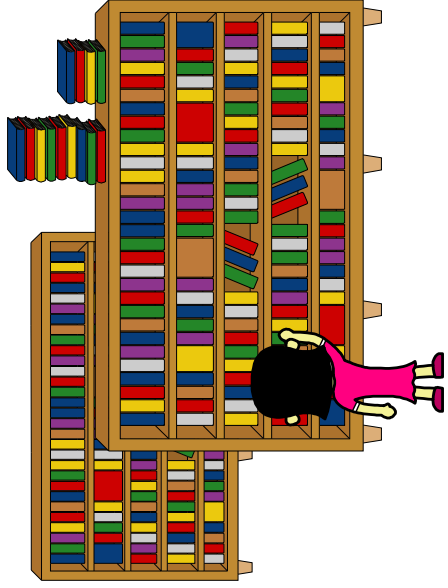

de bibliotheek

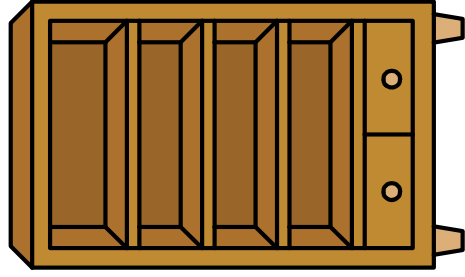

de kast

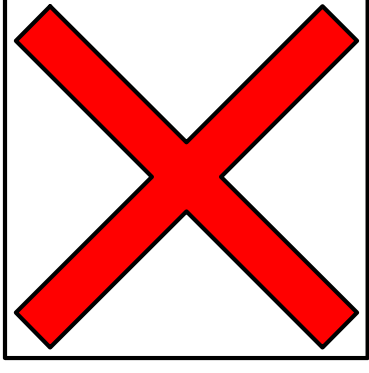

het kruisje

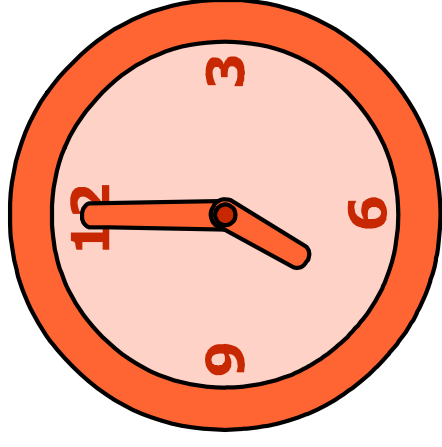

de klok

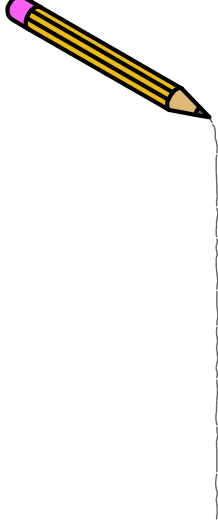

de lijn / de streep

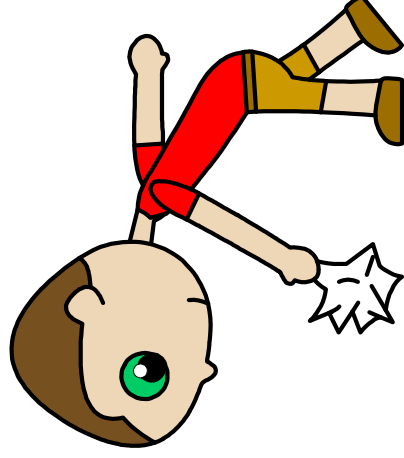

oprappen

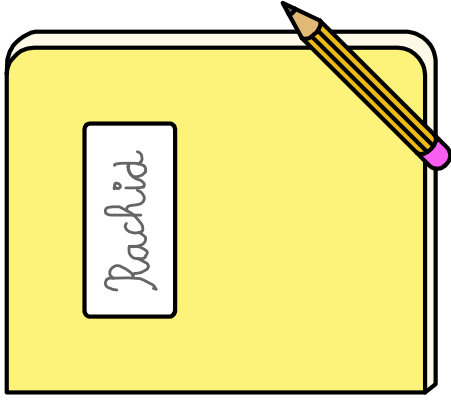

het schrift

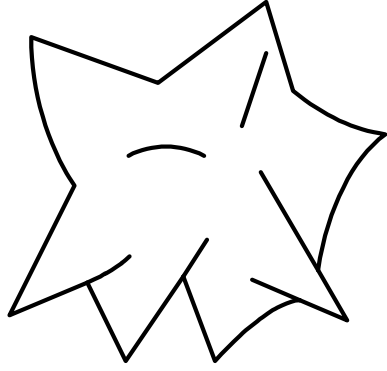

de prop

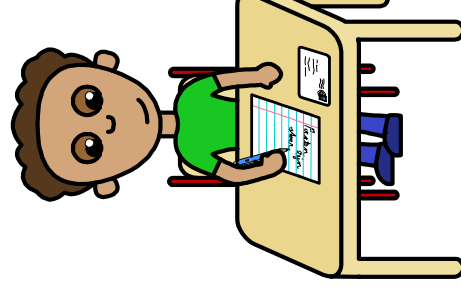

schrijven

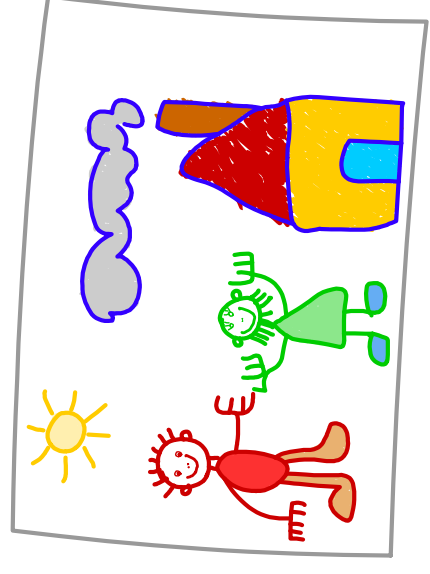

de tekening

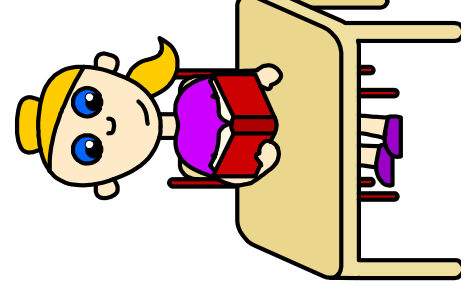

lezen



woord

het woord

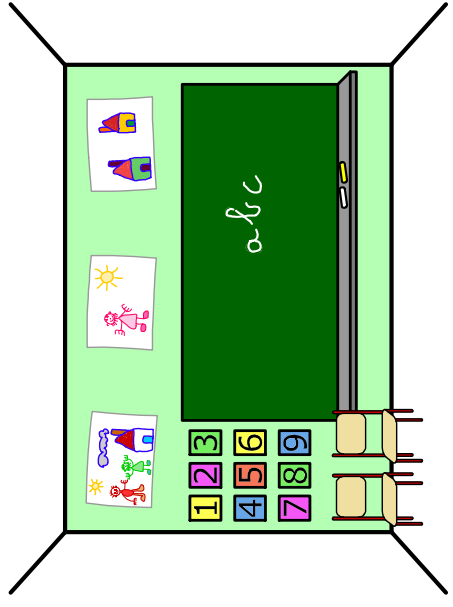

de klas



r

de letter

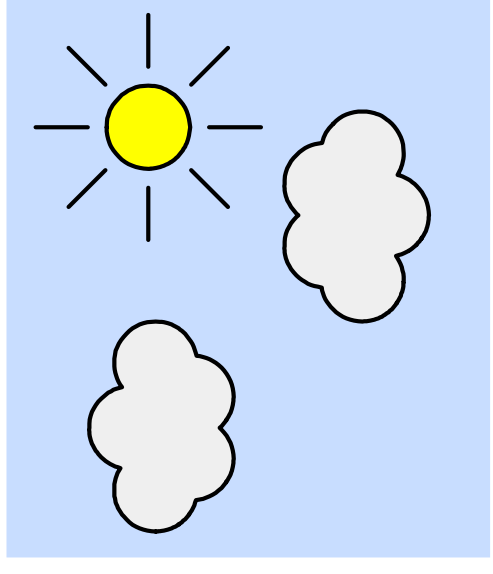

de dag

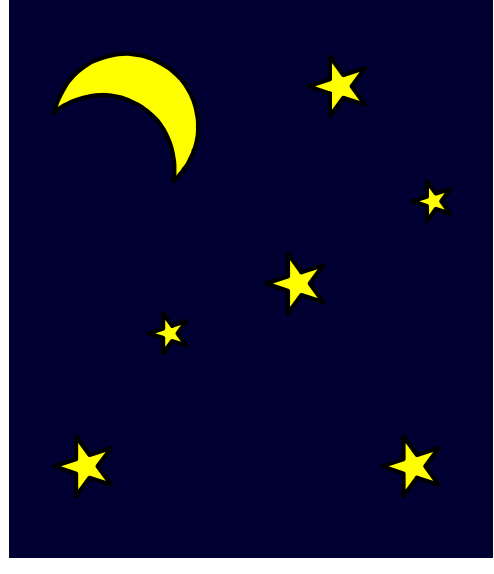

de nacht

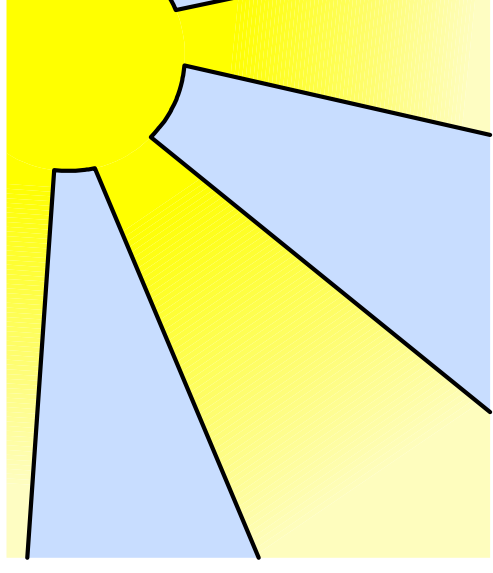

schijnen

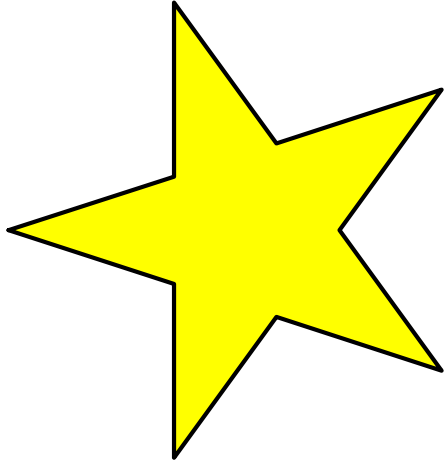

de ster

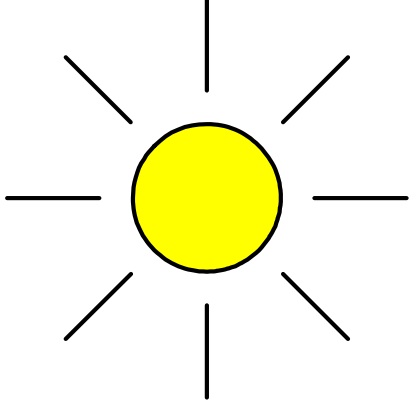

de zon

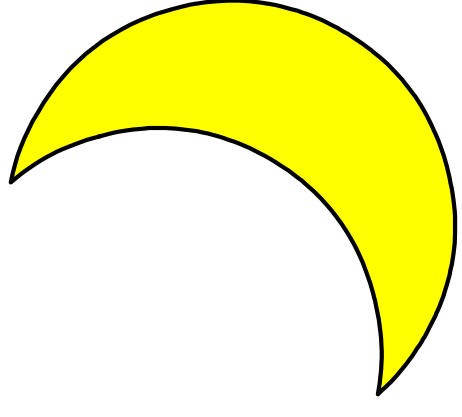

de maan

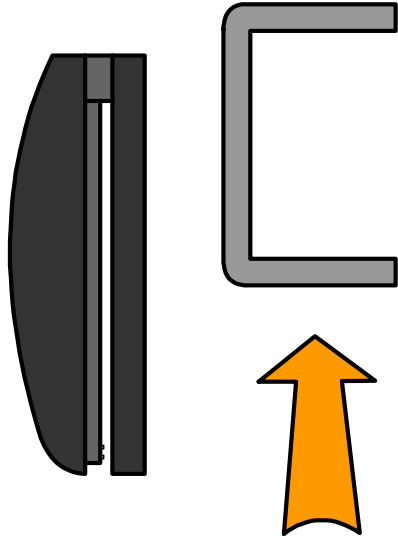

het nietje

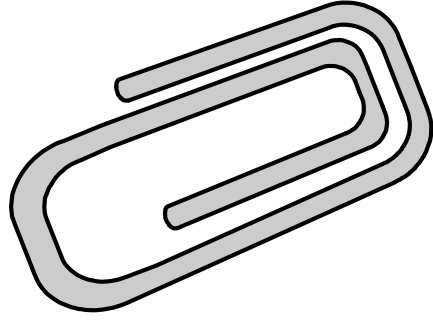

de paperclip

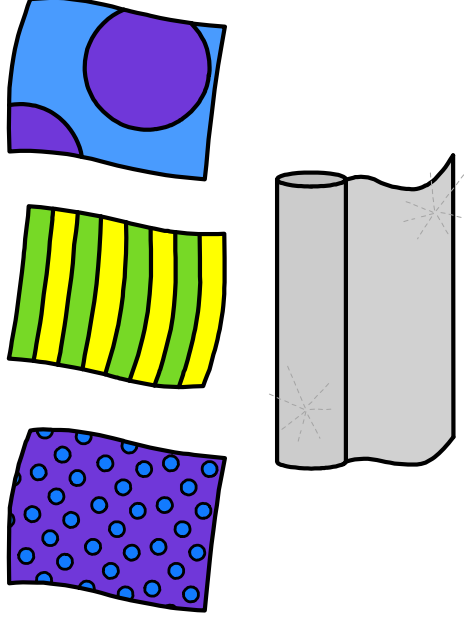

glad

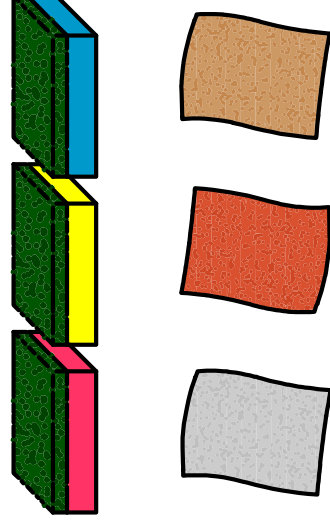

ruw

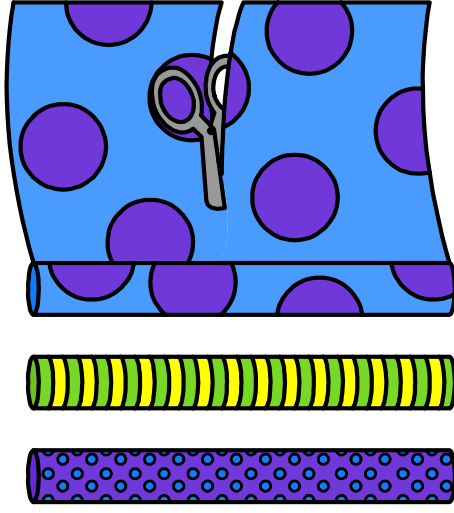

het inpakpapier

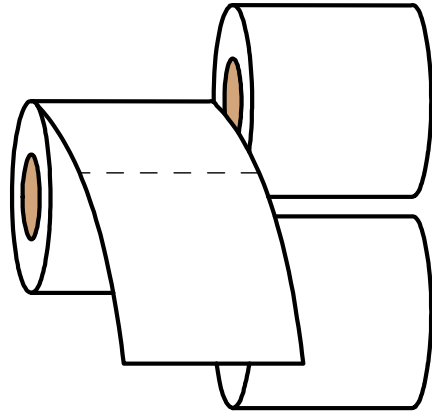

het wc-/toilet papier