

de ballon

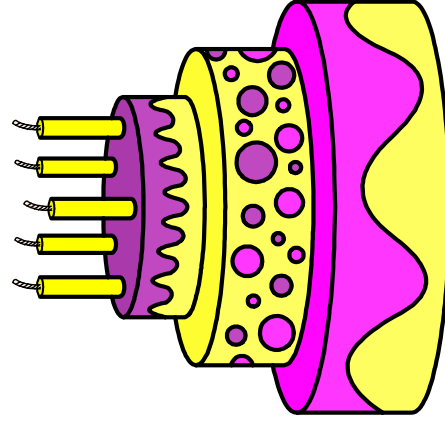

de taart

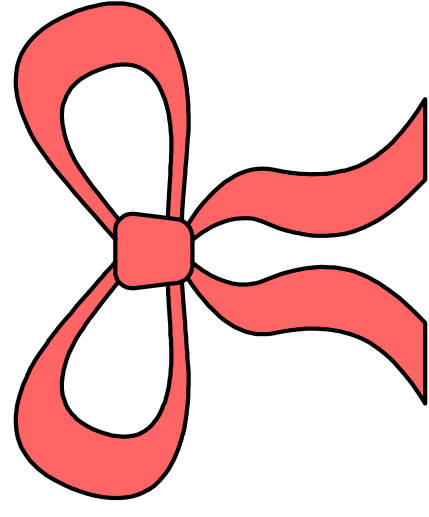

de strik

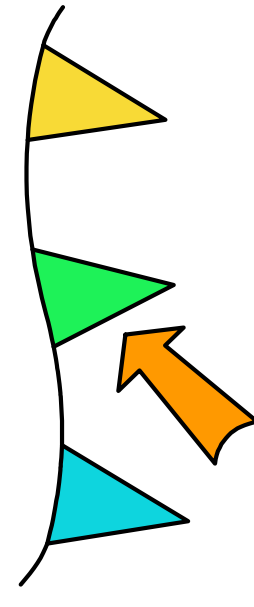

het vlaggetje

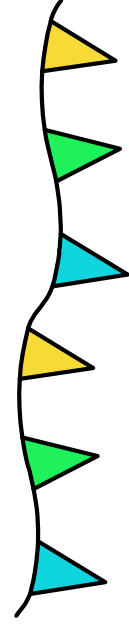

de slinger

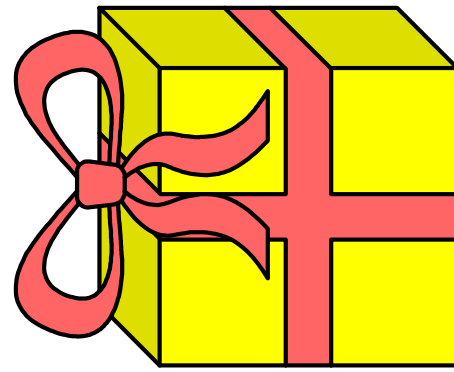

het cadeau(tje)

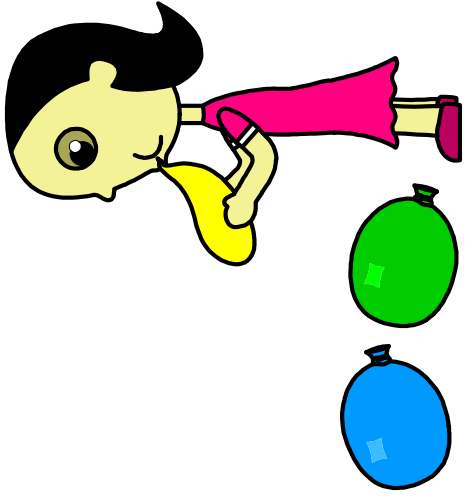

opblazen

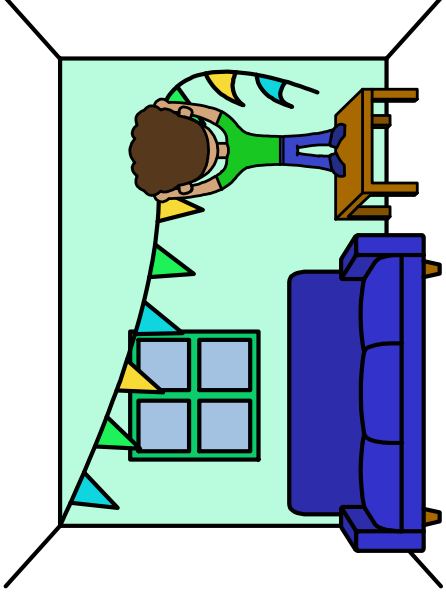

ophangen

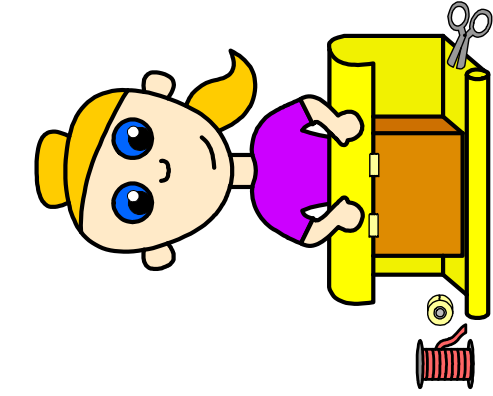

inpakken

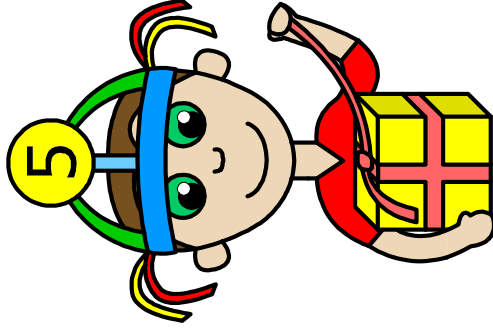

uitpakken

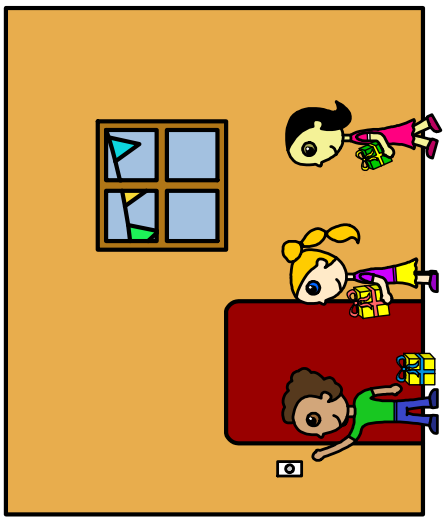

op visite gaan

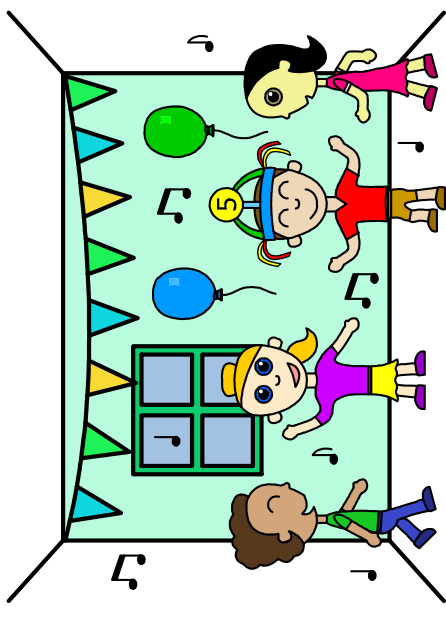

het feest

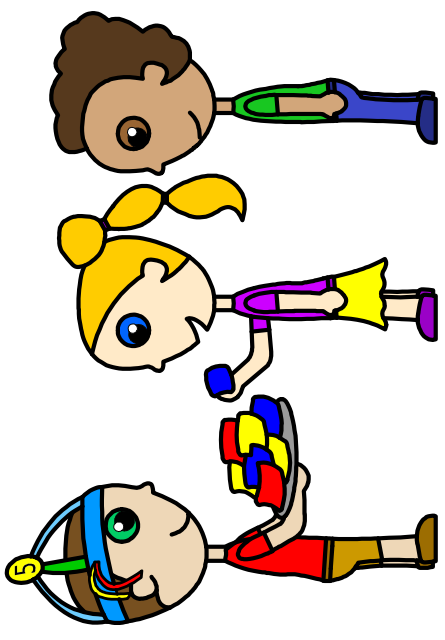

trakteren/uitdelen

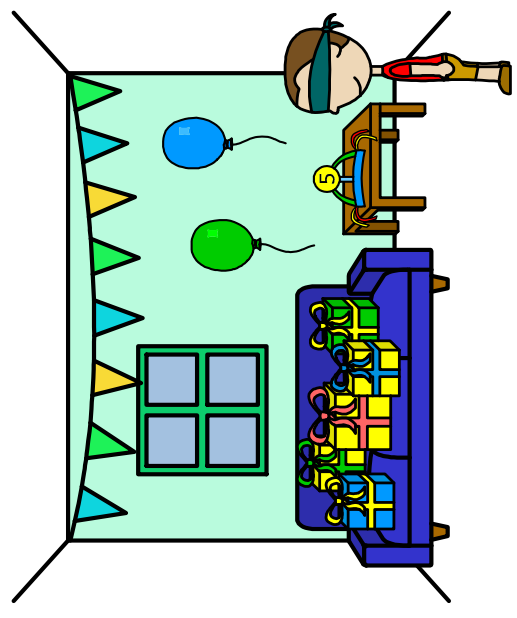

de verrassing

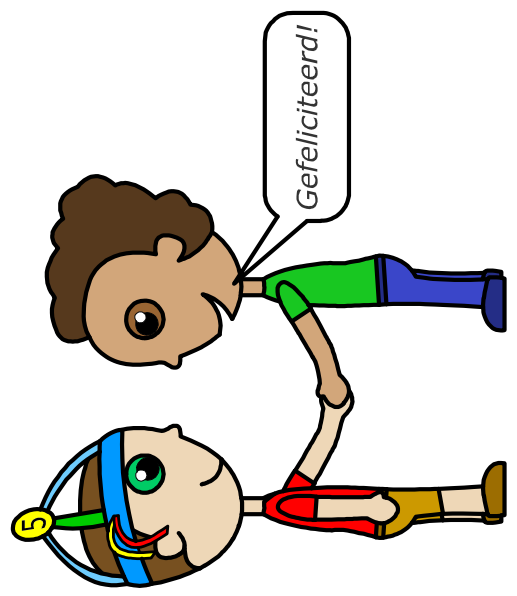

gefeliciteerd

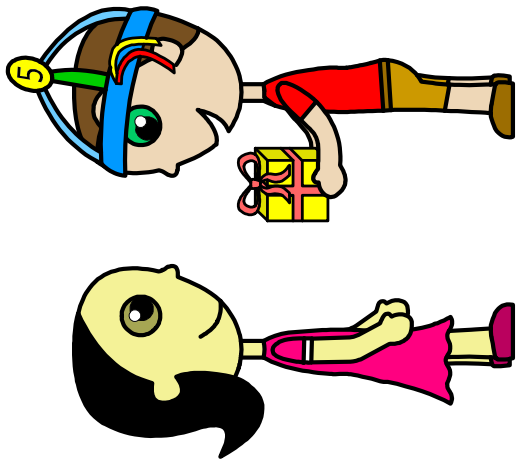

krijgen

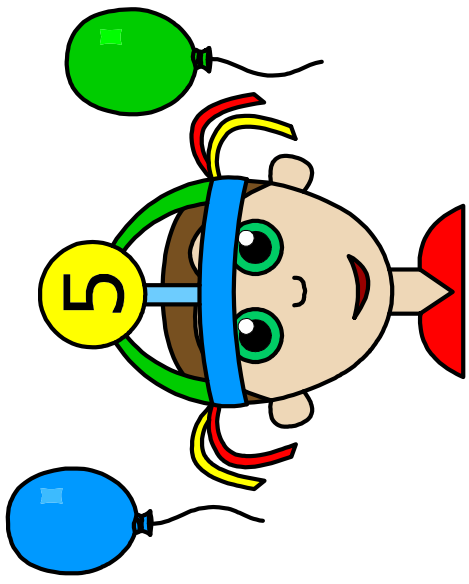

jarig zijn

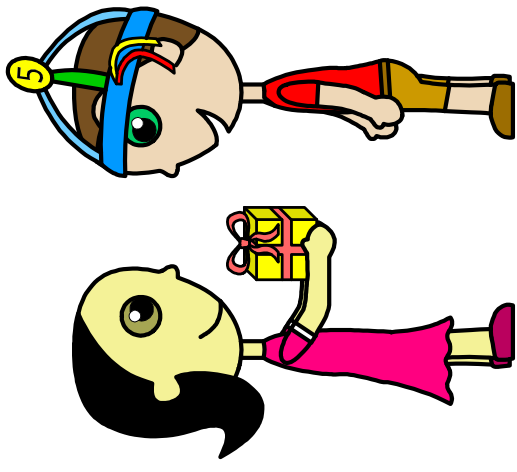

geven

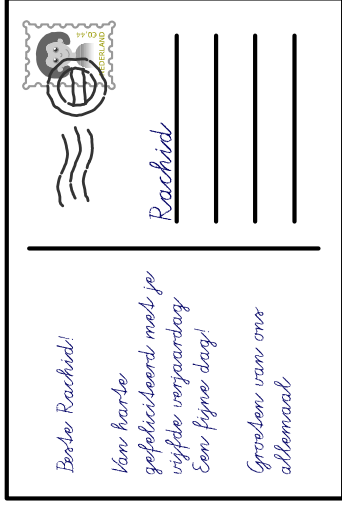

de kaart

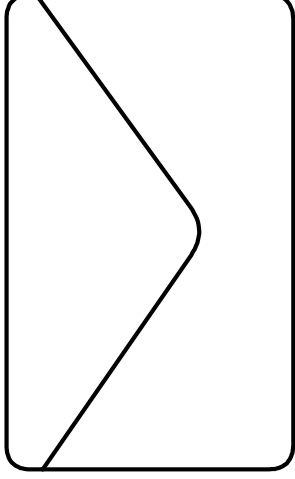

de envelop

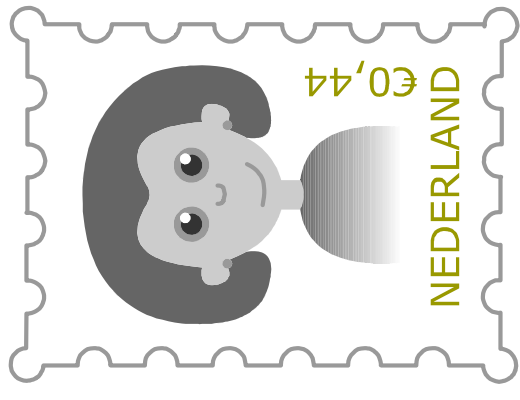

de postzegel

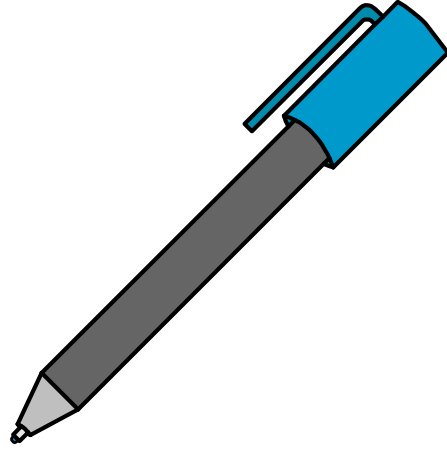

de pen

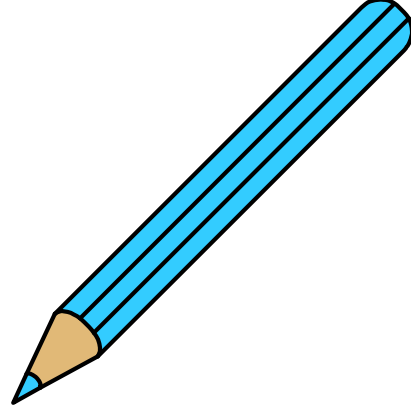

het (kleur)potlood

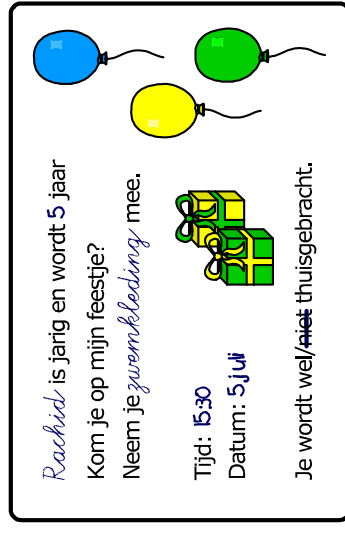

de uitnodiging

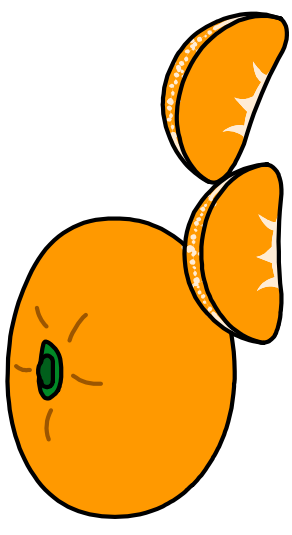

de mandarijn

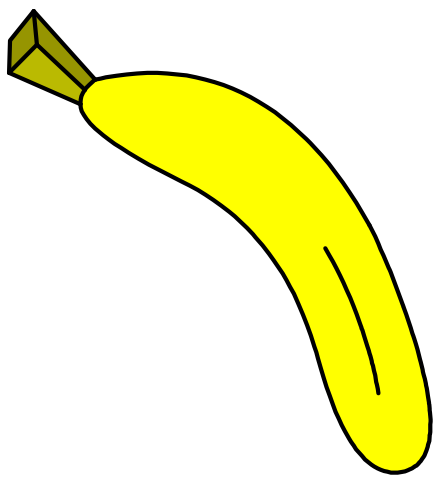

de banaan

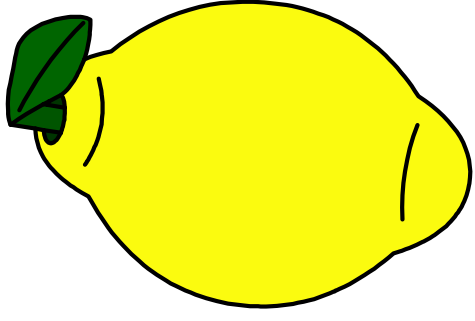

de citroen

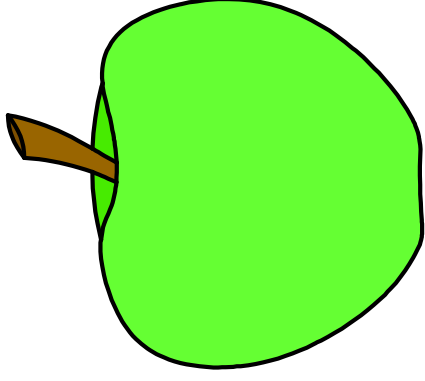

de appel

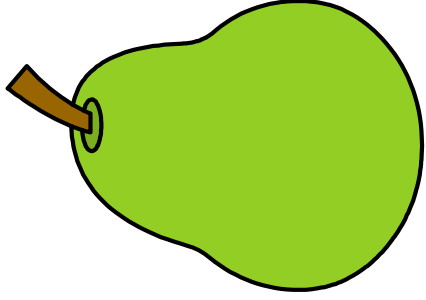

de peer

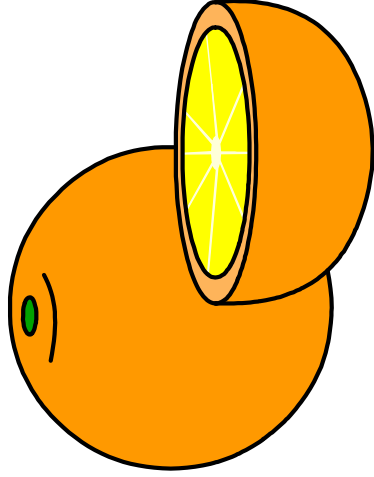

de sinaasappel

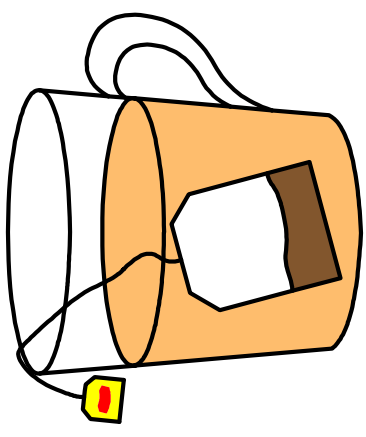

de thee

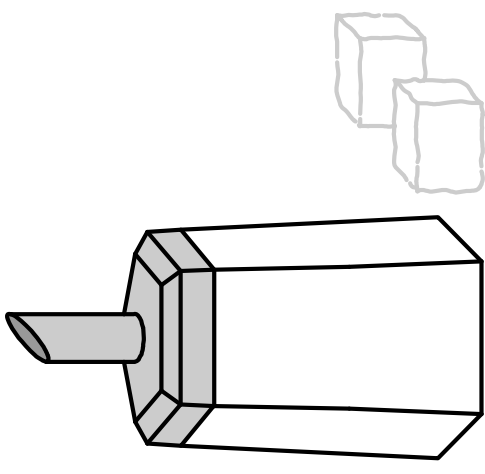

de suiker

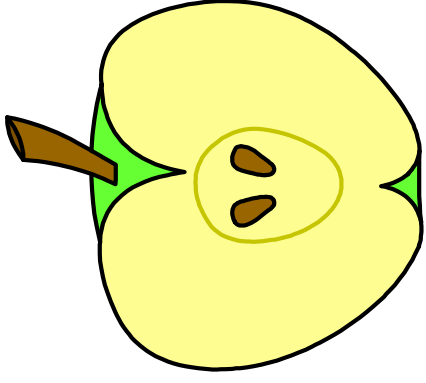

de helft

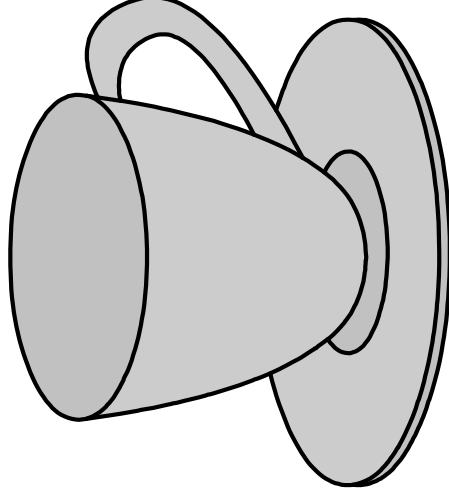

het kopje

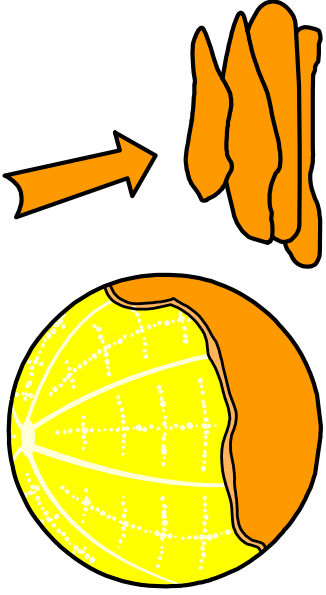

de schil

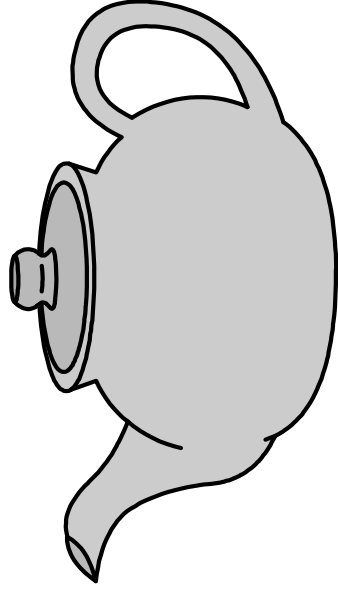

de theepot

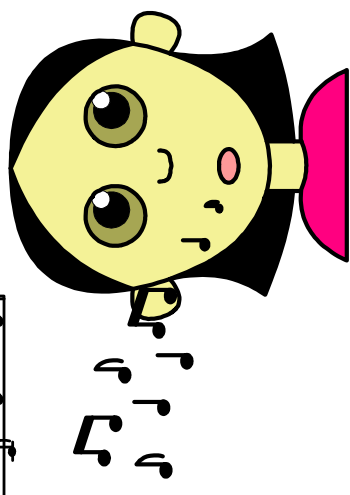
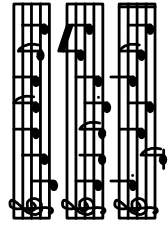

zingen

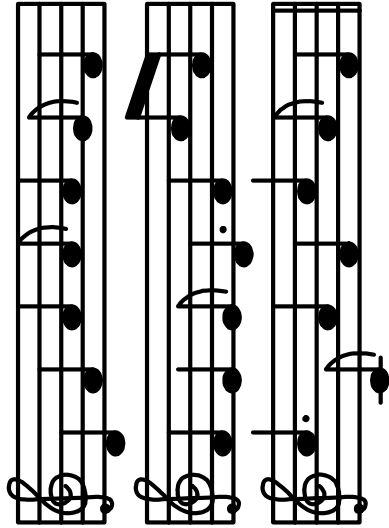

het liedje

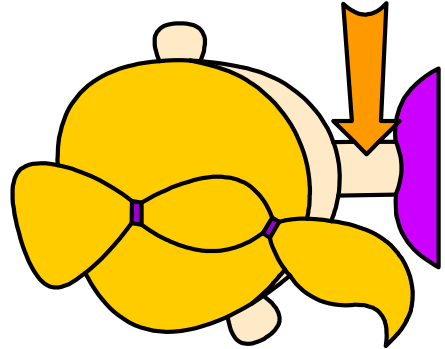

de nek

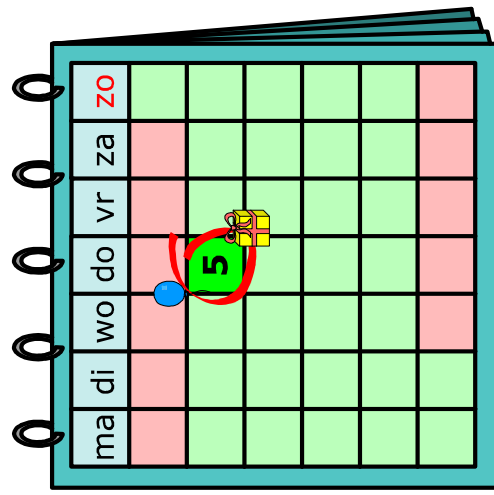

de verjaardag

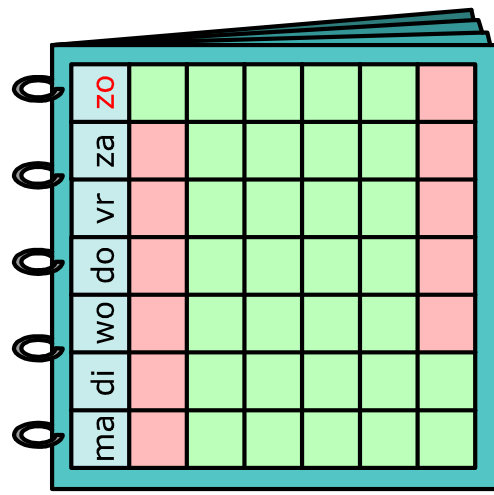

de kalender

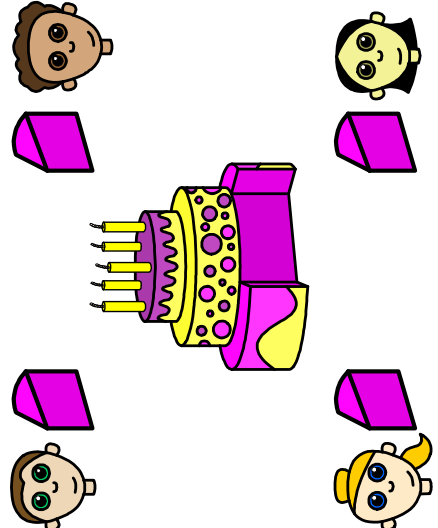

delen